

**VOLUME 2**  
**CAB PARTS**  
**(NON-ELECTRICAL)**  
**INCLUDING PANEL MOUNTING**  
**HARDWARE ADDENDUM**

**CAB PARTS**  
**NON-ELECTRICAL**

**July 17, 2000 Revision**

*CAB REPLACEMENT PARTS ARE SUBASSEMBLIES OF THE BASIC CAB WHICH CAN BE INSTALLED IN THE FIELD. THIS VOLUME DESCRIBES THE NON-ELECTRICAL RELATED CAB PARTS AVAILABLE. IT SHOULD BE UTILIZED IN CONJUNCTION WITH THE OTHER TWO VOLUMES.*

<b><u>VOLUME SET 2</u></b>		
VOLUME 1	--	CAB STYLES
VOLUME 2	--	CAB PARTS (NON-ELECTRICAL)
VOLUME 3	--	CAB PARTS (ELECTRICAL)

**PLEASE NOTE:**

**ILLUSTRATIONS ARE INDICATIVE OF CAB STYLE AND RELEVANT PARTS; THE ILLUSTRATIONS ARE NOT MEANT TO BE COLLECTIVELY EXHAUSTIVE.**

**CORRECT CAB PARTS SELECTION REQUIRES THE MANUFACTURER OF THE TRUCK, MARTIN CAB MODEL NUMBER, MARTIN CAB SERIAL NUMBER INFORMATION AND COLOR.**

**FOR GENERAL ASSISTANCE OR PARTS NOT LISTED, CALL MARTIN CAB SALES AT (888) 289-8900.**

United States Patents		Patents Pending		European Patents
Des. 279660	Des. 348553	1126310	1271005	BE,FR,GB,IT,ES (Euro)
4688846	4675933	1276206	1127208	0680431
4392669	4702516	1267925	1287653	Deusches Patentamt
4619479	5286081			69412454.0.

# Generic Cab Program

## PARTS GUIDE

For assistance and for additional parts guides at no charge, please contact Martin Cab Service Parts toll free (888) 289-8900.

### CAB PANEL MOUNTING HARDWARE ADDENDUM

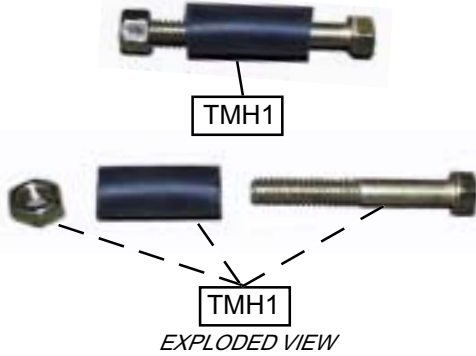

#### ROOF PANEL MOUNTING HARDWARE

	<u>Description</u>	<u>P/N</u>
<b>TMH1</b>	Roof retaining bolt/nut kit .....	

**Application:** System I, II, II+, III, IV & SV-XL



#### ROOF PANEL MOUNTING HARDWARE *Continued*

	<u>Description</u>	<u>P/N</u>
<b>TMH2</b>	Roof Top "J" Clamps As Required .....	70-1

**Application:** System I, II, II+, III, IV & SV-XL

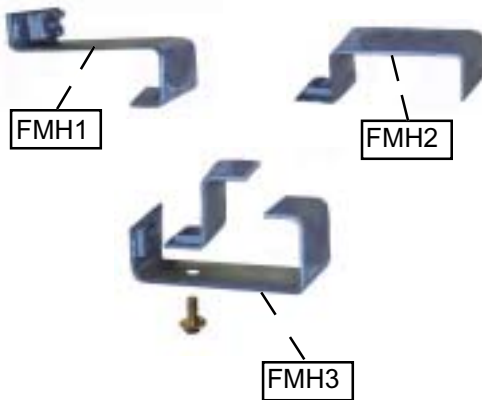

#### FRONT PANEL MOUNTING HARDWARE

	<u>Description</u>	<u>P/N</u>
<b>FMH1</b>	Front Panel "J" Clamps As Required .....	
<b>FMH2</b>	Front Panel "U" Clamps As Required .....	
<b>FMH3</b>	Front Panel Capture Clamps As Required .....	

**Application:** System II, II+, III, IV & SV, SV-XL

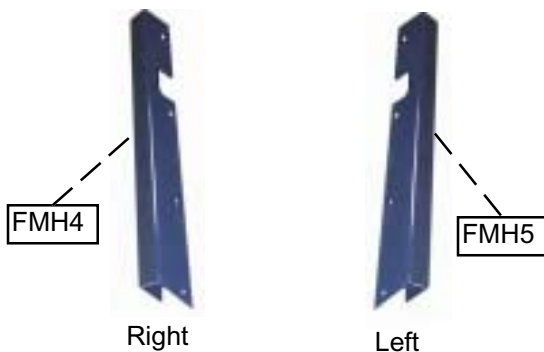

#### FRONT PANEL MOUNTING HARDWARE *Continued*

	<u>Description</u>	<u>P/N</u>
<b>FMH4</b>	Front Panel Mounting Channel (Right) .....	3050-R
<b>FMH5</b>	Front Panel Mounting Channel (Left) .....	3050-L

**Application:** System II, II+, III, IV & SV, SV-XL

**Note:**

*Figures are for illustration purposes only; various cabs may differ.*

"Martin Cab", "Innovators", are registered Trademarks of Martin Sheet Metal Inc. HV, Hi-Visibility, System 1-4 are all Trademarks of Martin Sheet Metal Inc.

# Generic Cab Program

## PARTS GUIDE

For assistance and for additional parts guides at no charge, please contact Martin Cab Service Parts toll free (888) 289-8900.

### CAB PANEL MOUNTING HARDWARE ADDENDUM

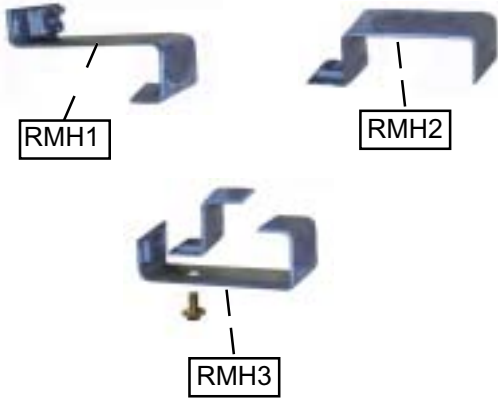

#### ROOF PANEL MOUNTING HARDWARE

<u>Description</u>	<u>P/N</u>
<b>RMH1</b> Front Panel "J" Clamps As Required .....	
<b>RMH2</b> Front Panel "U" Clamps As Required .....	
<b>RMH3</b> Front Panel Capture Clamps As Required .....	

**Application:** System II+, IV & SV-XL

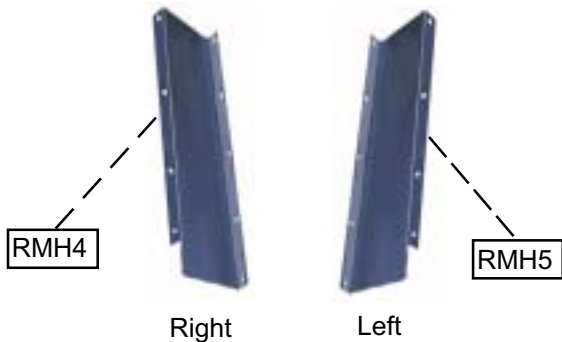

#### ROOF PANEL MOUNTING HARDWARE *Continued*

<u>Description</u>	<u>P/N</u>
<b>RMH4</b> Rear Panel Mounting Channel (Right) .....	4050-R
<b>RMH5</b> Rear Panel Mounting Channel (Left) .....	4050-L

**Application:** System II+, IV & SV-XL

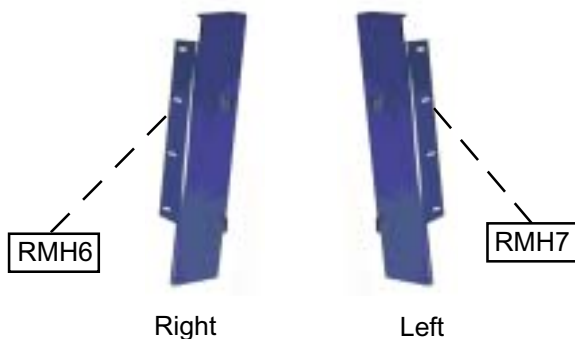

#### REAR PANEL MOUNTING HARDWARE *Continued*

<u>Description</u>	<u>P/N</u>
<b>RMH6</b> Rear Panel Mounting Bracket .....	24050R w/Door Hinges (Right)
<b>RMH7</b> Rear Panel Mounting Bracket .....	24060L w/Door Hinges (Left)

**Application:** System II+, IV & SV-XL

**Note:**  
*Figures are for illustration purposes only;  
 various cabs may differ.*

"Martin Cab", "Innovators", are registered Trademarks of Martin Sheet Metal Inc.  
 HV, Hi-Visibility, System 1-4 are all Trademarks of Martin Sheet Metal Inc.

# Generic Cab Program

## PARTS GUIDE

For assistance and for additional parts guides at no charge, please contact Martin Cab Service Parts toll free (888) 289-8900.

### SECTION 3

#### FRONT PANEL PARTS

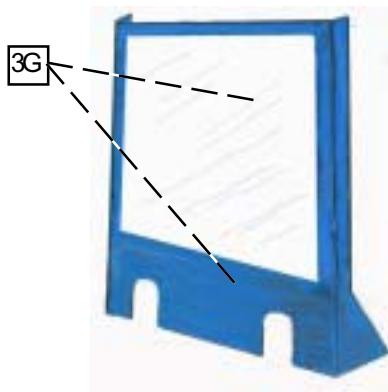
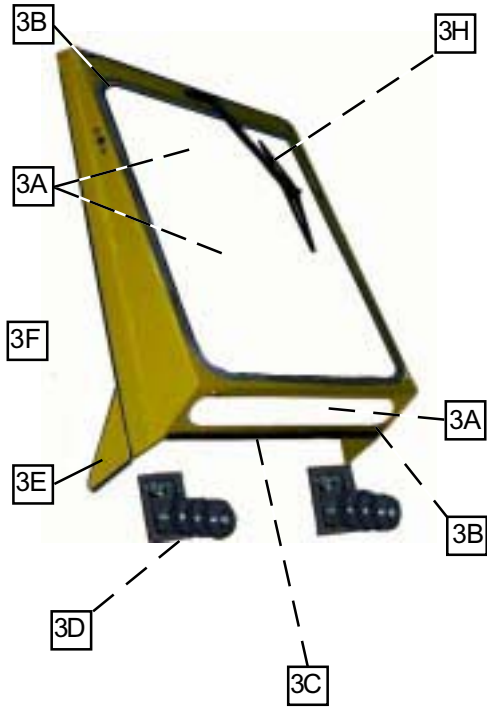

Description	P/N
<b>3A</b> Windshields:	
Front - Clear Laminated .....	301
Front - Tinted Laminated .....	301/T
Front - Clear Lexan .....	301/L
Front - Trapezoidal Alum. Frame (Clr. Lam.) .....	301-P
Front - Heat Shield System (Clear Hi-Temp Glass) .	301-HS
Front - Heat Shield System (Clear Lexan) .....	301/L-HS
Right - Clear Laminated .....	301-1
Right - Clear Lexan .....	301-1/L
Right Auxiliary - Clear Laminated .....	334-R
Lower-Clear Laminated .....	301-1-1
Lower-Tinted Laminated .....	301-1-1T
Upper - Clear Laminated .....	301-1U
Upper Left - Tinted Laminated .....	301/T-UL
Upper Right - Tinted Laminated .....	301/T-UR
Left - Clear Laminated .....	301-2
Left - Clear Lexan .....	301-2/L
Left - Tinted Laminated .....	301-3
<b>3B</b> Rubber Windshield Mounting Kits:	
Front Window .....	302
Front-Lower Window Mounting Rubber .....	302-1
<b>3C</b> Front- Panel Seal:	
Seal & Trim Kit Complete .....	304
<b>3D</b> Cylinder Covers:	
Left Cylinder Cover .....	304/LH
Right Cylinder Cover .....	304/RH
Fabric Cab Left Cylinder Cover .....	FABRIC-7-304L
Fabric Cab Right Cylinder Cover .....	FABRIC-7-304R
<b>3E</b> Front Fins:	
Left Front Fin .....	304-LH
Right Front Fin .....	304-RH
<b>3F</b> Front Fillers ( <i>various applications and locations</i> ):	
Left Filler .....	330/LH
Right Filler .....	330/RH
<b>3G</b> Fabric:	
Front Panel .....	Fabric-3
<b>3H</b> Wiper <i>Mandatory Accessory for Front Panel</i>	
<i>See Volume 3 for Available Parts</i>	

Note:

*Figure is for illustration purposes only; various cabs may differ.*

"Martin Cab", "Innovators", are registered Trademarks of Martin Sheet Metal Inc.  
 HV, Hi-Visibility, System 1-4 are all Trademarks of Martin Sheet Metal Inc.

**SECTION 3 (Continued)**

**FRONT PANELS**  
**FOR FACTORY GUARDS**

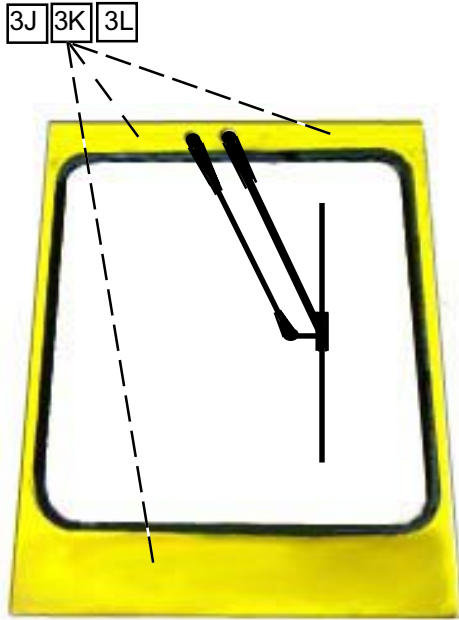

	<u>Description</u>	<u>P/N</u>
3J	Front Panel Only For Factory Guard ..... For Trucks 4,000-6,000 lb Capacity w/Standard/Pantographic Wiper - 12 Volt <sup>1</sup> w/Clear Laminated Glass	3000-2222-1
3K	Front Panel Only For Factory Guard ..... For Trucks 2,500-3,900 lb Capacity w/Standard/Pantographic Wiper - 12 Volt <sup>1</sup> w/Clear Laminated Glass	3000-2222-3
3L	Front Panel Only For Factory Guard ..... For Trucks 6,500-10,000 lb Capacity w/Standard/Pantographic Wiper - 12 Volt <sup>1</sup> w/Clear Laminated Glass	3000-2222-4

• *Due to Continual Product Change, Certain Model Trucks May Not Have Panels Available.*

<sup>1</sup> *Front Wiper Included with These Front Panels Are 12 Volts. Also Available Are 24, 36, & 48 Volt Wiper Systems .*

Note:

*Figure is for illustration purposes only; various cabs may differ.*

"Martin Cab", "Innovators", are registered Trademarks of Martin Sheet Metal Inc. HV, Hi-Visibility, System 1-4 are all Trademarks of Martin Sheet Metal Inc.

**SECTION 4**

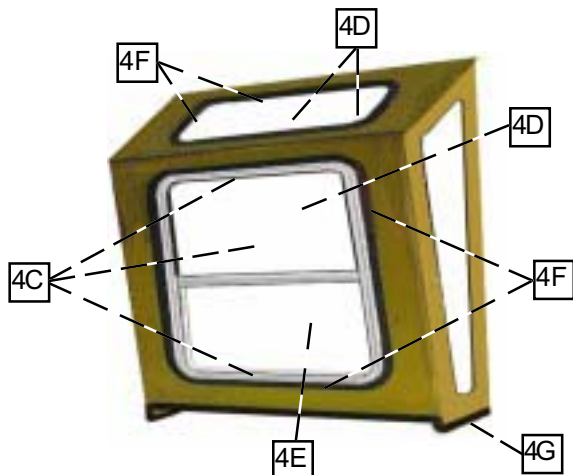
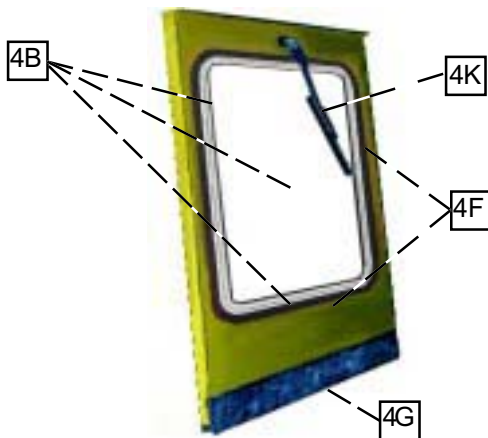
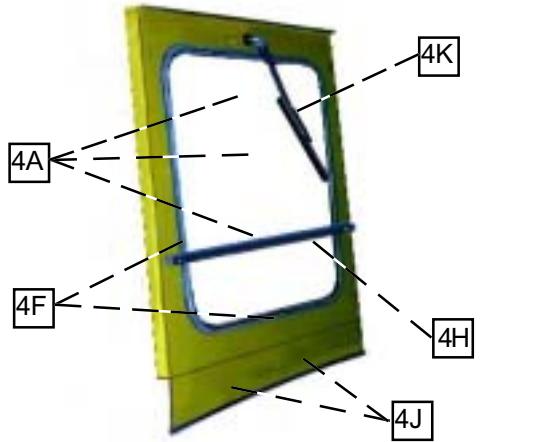

Note:

*Figure is for illustration purposes only; various cabs may differ.*

**REAR PARTS**  
**(EXCLUDING REAR HATCHES & DOORS)**

Description	P/N
<b>4A</b> Rear Windows:	
Clear Laminated .....	401-1
Standard Clear Lexan .....	401-1/L
Tinted Laminated .....	401/T
<b>4B</b> Rear Windows (Aluminum Framed):	
Standard Clear Lexan .....	4001-0002-2
Tinted Laminated .....	4001-0002-T
<b>4C</b> Rear Windows (Aluminum Framed Sliding):	
Clear Laminated .....	4001-0002
w/Lower Horizontal Slider (not Shown)	
Clear Laminated Upper .....	4001-0002-1
w/Lower Plexiglass Vertical Slider	
<b>4D</b> Upper Rear Windows:	
Clear Laminated .....	401-3
Clear Lexan .....	401-4L-1
<b>4E</b> Lower Rear Windows:	
Clear Laminated .....	401-4
Clear Lexan .....	401-4L
<b>4F</b> Rear Window Mounting:	
Rear Window Mounting Kit-Complete .....	402
<b>4G</b> Rear Seal:	
Rear Panel Trim & Seal Kit-Complete .....	404
<b>4H</b> Rear Window Bar:	
3/8" x 1" Steel Bar to Straddle Window .....	4000-0002-02
<b>4J</b> Lower Panel:	
Lower Panel Complete with Seal Rubber ....	490
<b>4K</b> Wiper <i>Optional Accessory for Rear Panel</i>	
<i>See Volume 3 for Available Parts</i>	

**SECTION 4 (CONTINUED)**

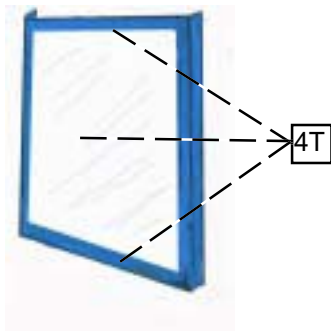
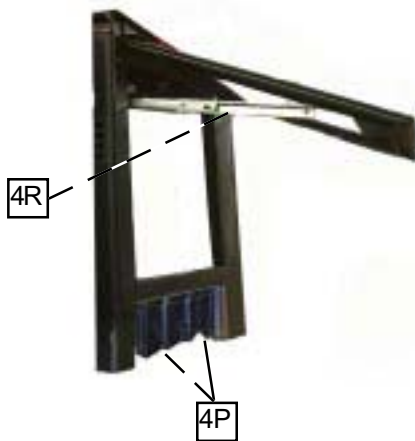

**Note:**

*Figure is for illustration purposes only; various cabs may differ.*

**REAR PARTS**  
**(EXCLUDING REAR HATCHES & DOORS)**  
*Continued*

	<u>Description</u>	<u>P/N</u>
4L	Rear Hatch Hinge: Continuous-Painted Matching Cab Color .....	4000-TOP-CH w/Hardware
4M	Rear Auxilliary Window: Clear Laminated Glass-Left Side .....	401-5-1-LH
	Clear Laminated Glass-Right Side .....	401-5-1-RH
	Standard Clear Lexan-Left Side .....	401-5-2L-L
	Standard Clear Lexan-Right Side .....	401-5-2L-R
4N	Lower Rear Windows: Clear Laminated .....	401-4
	Standard Clear Lexan .....	401-4L
4P	Rear Filler: Lower Fabric Filler .....	490-01
4R	Support Arms ( <i>Model Specific</i> ): Telescoping w/Bolt Kit or Gas Cylinder Type ...	499-02
4S	Side Fillers: Right Side Filler w/Gaskets (Not Shown) .....	430-RH
	Left Side Filler w/Gaskets (Not Shown) .....	430-LH
4T	Fabric: Rear Panel .....	Fabric-4

**SECTION 5**

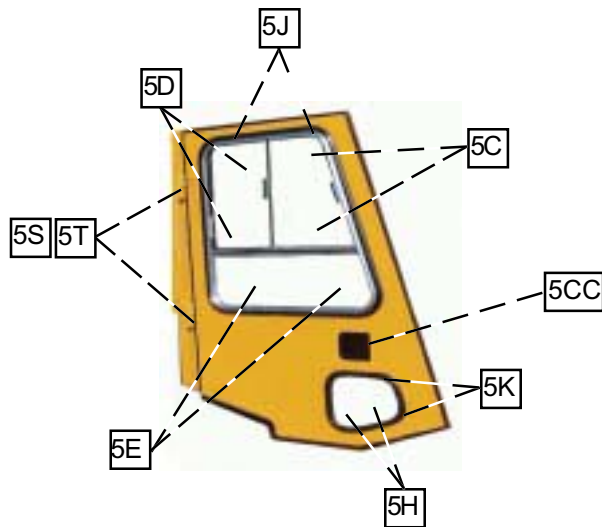
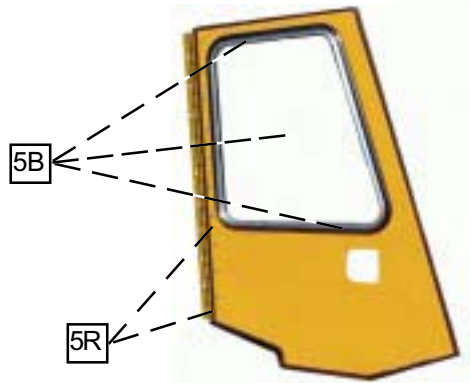
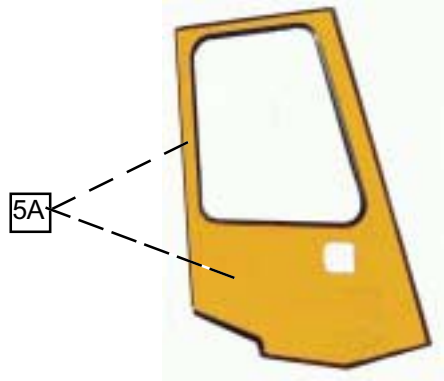

Note:

*Figure is for illustration purposes only; various cabs may differ.*

**RIGHT SIDE DOOR PARTS**

<u>Description</u>	<u>P/N</u>
<b>5A</b> Door Assemblies:	
Basic Design-Clear Laminated .....	5000-01
Basic Design-Lower Window if req'd .....	5000-01-A
Basic Design-Tinted Laminated .....	5000-01-B
Basic Design-All Rubber Seal Gaskets .....	5000-01-C
Does Not Include:	
Aluminum Framed Window, Hinges, Lower Window Glass, Latch Or Hardware	
Basic Design-Standard Clear Lexan .....	5000-02-LEX
Special Heat Shield .....	5000-HS
<b>5B</b> Side Windows:	
Alum. Frame Only .....	5001-0000
Alum. Framed Window w/Laminated Glass .....	5001-0002
Alum. Framed Window w/Tinted Laminated ....	5001-0002-T
Alum. Framed Window Lexan .....	5001-0002-L
<b>5C</b> Side Windows-3 Piece, Front:	
Clear Laminated .....	501F-1
Tinted Laminated .....	501F-1T
<b>5D</b> Side Windows-3 Piece, Rear:	
Clear Laminated .....	501R-1
Tinted Laminated .....	501R-1T
<b>5E</b> Side Windows-3 Piece, Stationary:	
Clear Laminated .....	501S-1
Tinted Laminated .....	501S-1T
<b>5F</b> Side Windows-2 Piece, Front:	
Clear Laminated .....	501F
Tinted Laminated .....	501FT
Standard Clear Lexan .....	501F-L
<b>5G</b> Side Windows-2 Piece, Rear:	
Clear Laminated .....	501R
Tinted Laminated .....	501RT
Standard Clear Lexan .....	501R-L

**SECTION 5 (CONTINUED)**

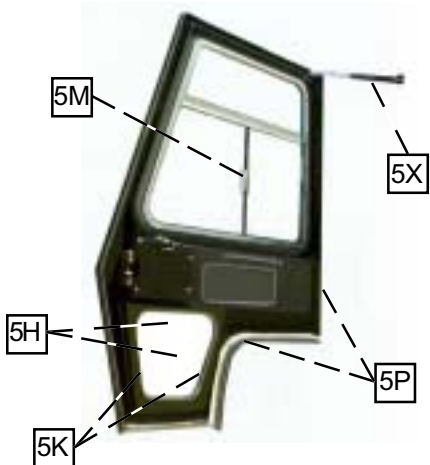
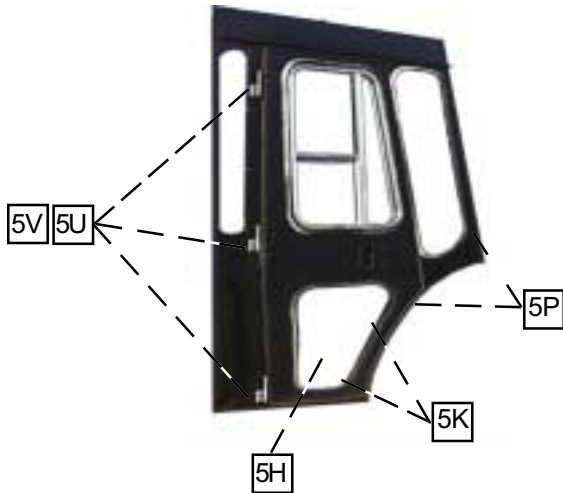
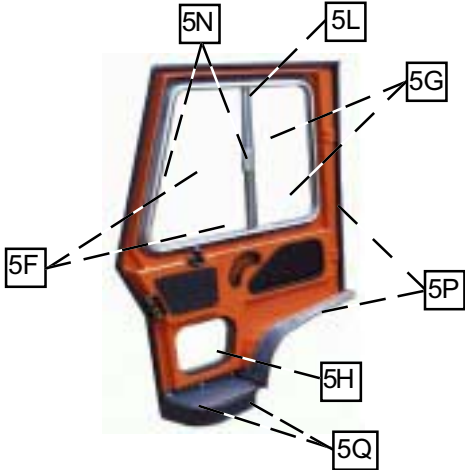

**RIGHT SIDE DOOR PARTS**  
*Continued*

<u>Description</u>	<u>P/N</u>
<b>5H</b> Lower Side Windows:	
Clear Laminated .....	501B
Tinted Laminated .....	501-BT
Standard Clear Lexan .....	501B-01
<b>5J</b> Door Window Mounting:	
Mounting Kit-Complete .....	502
<b>5K</b> Lower Side Windows Mounting:	
Mounting Kit-Complete .....	502-01
<b>5L</b> Center Post:	
Side Window Vertical Center Post .....	5001-0001
<b>5M</b> Window Latch:	
Locking w/Striker for Side Windows .....	5001-0001-A
<b>5N</b> Window Pulls:	
Mini-Pull for Side Window .....	5001-0002
Long Pull for Side Window .....	5001-0002-1
<b>5P</b> Door Seal:	
Trim & Seal Kit-Complete .....	504
<b>5Q</b> Threshold:	
Unit Kit-Complete .....	556/RH
<b>5R</b> Piano Style Hinge Kit:	
3/8" Dia Pin; 4" Open .....	5003-P
1/4" Dia Pin; 2-1/2" Open .....	5003-P-1
<b>5S</b> 2-Unit Male Hinge Kit:	
3/8" I.D. Barrel .....	5003-1
1/2" Pin for 9/16" I.D. Barrel .....	5003-2
9/16" C.R. Pin for 5/8" Barrel .....	5003-9-2
1/2" Pin for 9/16" I.D. Barrel (Spec Removeable) .....	5003-2-RF-1
<b>5T</b> 2-Unit Female Hinge Kit:	
3/8" I.D. Barrel .....	5001-1-F
9/16" I.D. Barrel for 1/2" Pin .....	5003-2-F
5/8" I.D. Barrel for 1/2" C.R. Pin .....	5003-9-F
9/16" I.D. Barrel for 1/2" Pin (Spec Removeable) .....	5003-2-RF

**Note:**

*Figure is for illustration purposes only; various cabs may differ.*

"Martin Cab", "Innovators", are registered Trademarks of Martin Sheet Metal Inc.  
 HV, Hi-Visibility, System 1-4 are all Trademarks of Martin Sheet Metal Inc.

**SECTION 5 (CONTINUED)**

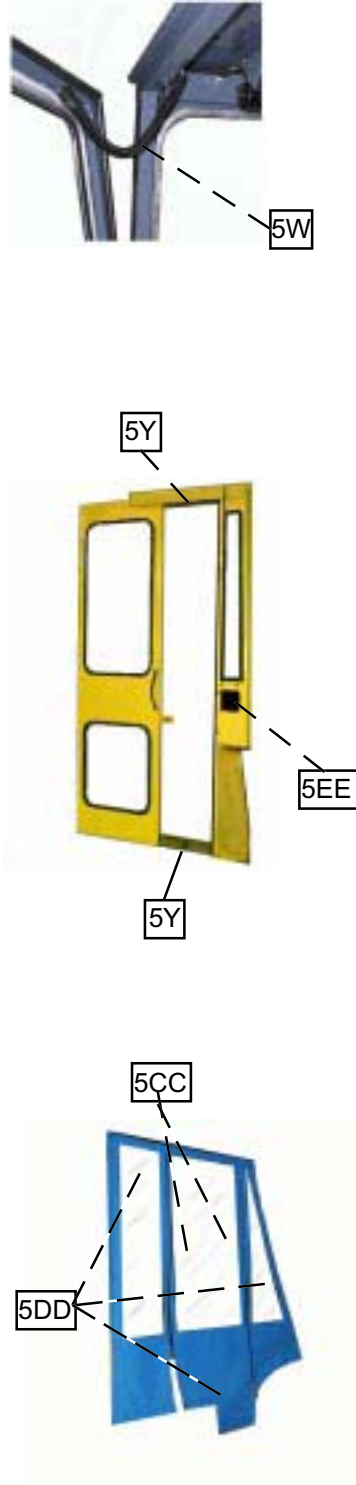

**RIGHT SIDE DOOR PARTS**  
***Continued***

<u>Description</u>	<u>P/N</u>
<b>5U</b> 3-Unit Male Hinge Kit:	
3/8" I.B. Barrel .....	5003-1-3
1/2" Pin for 9/16" I.D. Barrel .....	5003-2-3
9/16: C.R. Pin for 5/8" Barrel .....	5003-9-3
<b>5V</b> 3-Unit Female Hinge Kit:	
9/16" I.D. Barrel for 1/2" Pin .....	5003-2-3-F
5/8" I.D. Barrel for 1/2" C.R. Pin .....	5003-9-3-F
<b>5W</b> Door Hold Back:	
Door Hold Back-Right (Rubber Plunger) .....	DHB-R
Door Hold Back Base-Complete (Female) .....	DHB/F
Door Hold Back Base-Complete (Male) .....	DHB/M
Door Hold Back Chain (Sleeved) .....	DHB/C
Door Hold Back Chain (2) (Sleeved) .....	DHB/C-2
<b>5X</b> Gas Cylinder:	
Cylinder Including Mounting Hardware .....	5001-1
<b>5Y</b> Sliding Track:	
Pair- 22" Long .....	50003/ST-01
Pair- 30" Long .....	50003/ST-02
Pair- 36" Long .....	50003/ST-03
<b>5Z</b> Fin Seal:	
Fin Trim & Seal Kit-Complete (Not Shown) .....	574/RH
<b>5AA</b> Side Fin Cover:	
Cover-Complete (Not Shown) .....	575/RH
<b>5BB</b> Fuel Fill:	
Cover Kit (Not Shown) .....	599/RH
<b>5CC</b> Fabric:	
Door Only .....	Fabric-5-01
<b>5DD</b> Fabric:	
Complete Panel .....	Fabric-5-04
<b>5EE</b> Latches <i>See Subsequent Listings</i>	

Note:

*Figure is for illustration purposes only;  
 various cabs may differ.*

"Martin Cab", "Innovators", are registered Trademarks of Martin Sheet Metal Inc.  
 HV, Hi-Visibility, System 1-4 are all Trademarks of Martin Sheet Metal Inc.

**SECTION 5 (CONTINUED)**

**RIGHT SIDE DOOR PARTS**

*Continued*

**5EE LATCHES**

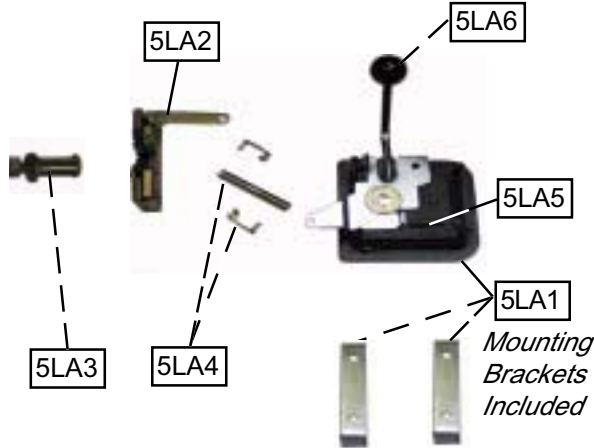

**5LA** COMPLETE ASSEMBLY

**BALL HANDLE STYLE**

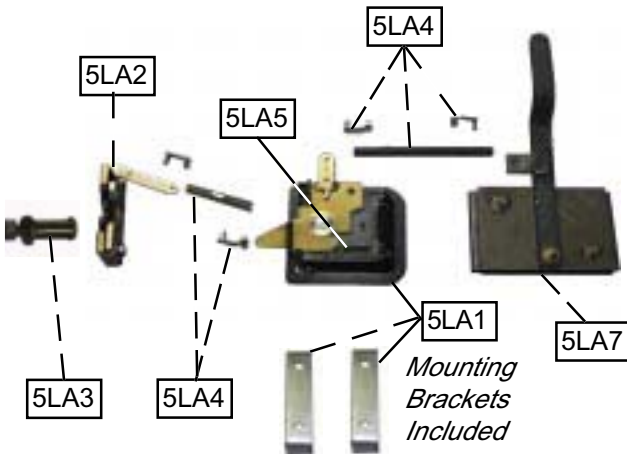

**5LA** COMPLETE ASSEMBLY

**LEVER HANDLE STYLE**

Note:

*Figure is for illustration purposes only; various cabs may differ.*

Description

P/N

<b>5LA</b>	Right Rotary Latch-Complete (Unkeyed) ..... <i>Includes Pertinent Mounting Hardware</i>	5002-3
	Right Rotary Latch-Complete (Keyed) ..... <i>Includes Pertinent Mounting Hardware</i>	5002-3-1
<b>5LA1</b>	Right Flush Paddle Latch - Outside ..... (Unkeyed Paddle Only) <i>Includes Pertinent Mounting Hardware</i>	5002-3-
	Right Flush Paddle Latch - Outside ..... (Keyed Paddle Only) <i>Includes Pertinent Mounting Hardware</i>	5002-3-1-
<b>5LA2</b>	Right Rotor Assembly Only ..... (For Rotary Latch Assembly)	5002-3-02
<b>5LA3</b>	Right Stricker Bolt ..... (w/Shoulder Washer and Hex Nut When Required)	5002-3-03
<b>5LA4</b>	Right Rotary Link with Clips .....	5002-3-04
<b>5LA5</b>	Right Return Spring .....	5002-3-9
<b>5LA6</b>	Right Plastic Ball .....	5002-3-91
<b>5LA7</b>	Inside Handle (w/Link If Required) ..... <i>Includes Pertinent Mounting Hardware</i>	5002-3-01

*Cab Model, Serial Number and Location  
**Extremely Important** For The Latches  
 On This Page*

**SECTION 5 (CONTINUED)**

**RIGHT SIDE DOOR PARTS**  
***Continued***

**5EE LATCHES**



<u>Description</u>	<u>P/N</u>
--------------------	------------

<b>5LB</b>	T-Type Standard (55): Right - Inside ..... 5002-01 <i>Includes Pertinent Mounting Hardware</i>
------------	--

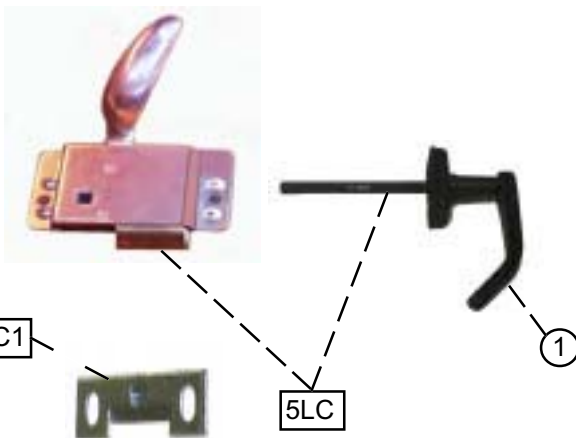

<u>Description</u>	<u>P/N</u>
--------------------	------------

<b>5LC</b>	T-Type Latch (55A) Inside - Complete ..... 5002-01 Outside (Unkeyed) - Complete ..... 5002-01-1 Outside (Keyed) - Complete ..... 5002-01-2
<b>5LC1</b>	Striker Only for T-Type Latch ..... 5002-01-3 (Right & Left Same)

① *Obsolete Part (Special Order)*

Note:

*Figure is for illustration purposes only;  
 various cabs may differ.*

*Above Includes Pertinent Mounting Hardware where required*

"Martin Cab", "Innovators", are registered Trademarks of Martin Sheet Metal Inc.  
 HV, Hi-Visibility, System 1-4 are all Trademarks of Martin Sheet Metal Inc.

**SECTION 5 (CONTINUED)**

**RIGHT SIDE DOOR PARTS**

*Continued*

**5EE LATCHES**

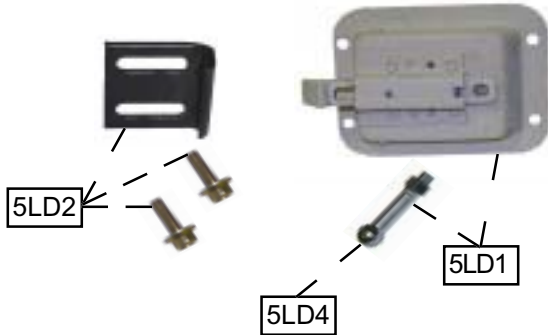

Description	P/N
<b>5LD1</b> Right Slam Latch Assembly: Unkeyed .....	5002-1
Keyed .....	5002-2
<b>5LD2</b> Standard Striker for Latch-Complete .....	5002-1-1
<b>5LD3</b> 90° Striker for Latch (Not Shown) .....	5002-1-2
<b>5LD4</b> Inside Extension Handle .....	5002-1-3

*Above Includes Pertinent Mounting Hardware where required*

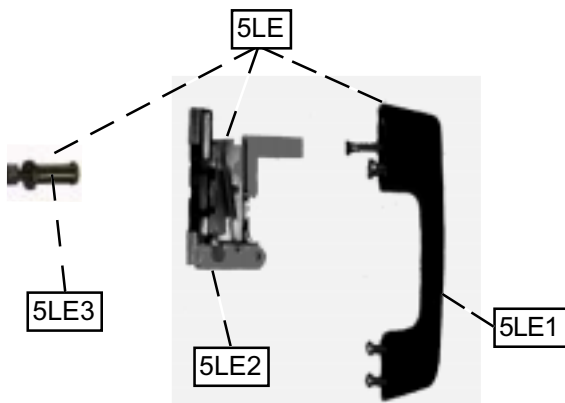

Description	P/N
<b>5LE</b> Grab Handle Latch Kit - Complete .....	5002-2-10
Locking Outside Handle Inside Latch Assembly Striker Bolt Mounting Hardware	
<b>5LE1</b> Grab Handle Latch - Outside .....	5002-2-11
Locking Outside Latch	
<b>5LE2</b> Grab Handle Latch .....	5002-2-12
Inside Latch Assembly	
<b>5LE3</b> Grab Handle Latch- Stricker Bolt .....	5002-2-13
(w/Shoulder Washer and Hex Nut When Required)	

*Above Includes Pertinent Mounting Hardware where required*

Note:

*Figure is for illustration purposes only;  
 various cabs may differ.*

"Martin Cab", "Innovators", are registered Trademarks of Martin Sheet Metal Inc.  
 HV, Hi-Visibility, System 1-4 are all Trademarks of Martin Sheet Metal Inc.

**SECTION 6**

**LEFT SIDE DOOR PARTS**

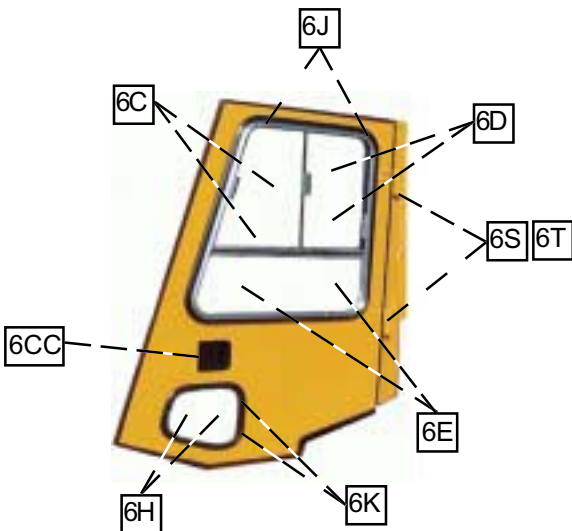
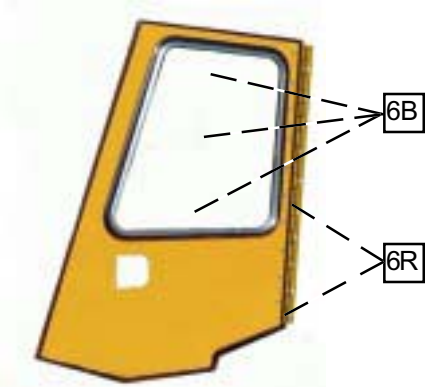
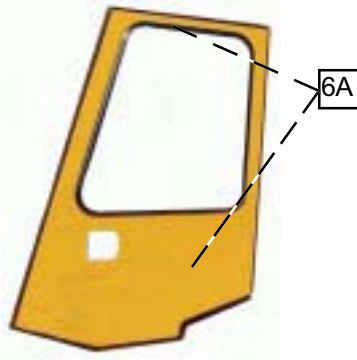

Note:

*Figure is for illustration purposes only; various cabs may differ.*

<u>Description</u>	<u>P/N</u>
<b>6A</b> Door Assemblies:	
Basic Design-Clear Laminated.....	6000-01
Basic Design-Lower Window if req'd .....	6000-01-A
Basic Design-Tinted Laminated .....	6000-01-B
Basic Design-All Rubber Seal Gaskets .....	6000-01-C
Does Not Include:	
Aluminum Framed Window, Hinges, Lower Window Glass, Latch Or Hardware	
Basic Design-Standard Clear Lexan .....	6000-02-LEX
Basic Design-Lexan & Keyed Latch .....	6000-02-LEX-1
Special Heat Shield .....	6000-HS
<b>6B</b> Side Windows:	
Alum. Frame Only .....	6001-0000
Alum. Framed Window w/Laminated Glass .....	6001-0002
Alum. Framed Window w/Tinted Laminated .....	6001-0002-T
<b>6C</b> Side Windows-3 Piece, Front:	
Clear Laminated .....	601F-1
Tinted Laminated .....	601F-1T
<b>6D</b> Side Windows-3 Piece, Rear:	
Clear Laminated .....	601R-1
Tinted Laminated .....	601R-1T
<b>6E</b> Side Windows-3 Piece, Stationary:	
Clear Laminated .....	601S-1
Tinted Laminated .....	601S-1T
<b>6F</b> Side Windows-2 Piece, Front:	
Clear Laminated .....	601F
Tinted Laminated .....	601FT
Clear Lexan .....	601F-L
<b>6G</b> Side Windows-2 Piece, Rear:	
Clear Laminated .....	601R
Tinted Laminated .....	601RT
Clear Lexan .....	601R-L

"Martin Cab", "Innovators", are registered Trademarks of Martin Sheet Metal Inc.  
 HV, Hi-Visibility, System 1-4 are all Trademarks of Martin Sheet Metal Inc.

**SECTION 6 (CONTINUED)**

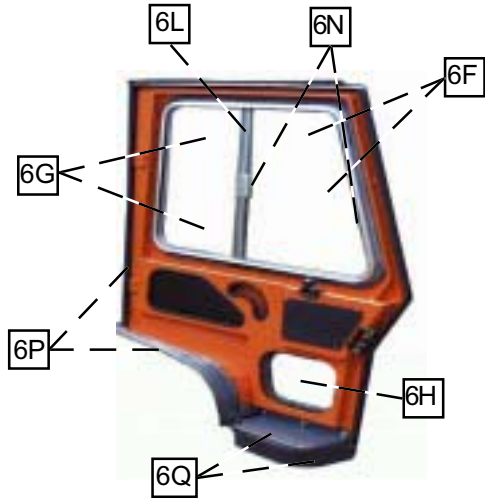

Note:  
*Figure is for illustration purposes only;  
 various cabs may differ.*

**LEFT SIDE DOOR PARTS**  
**Continued**

<u>Description</u>	<u>P/N</u>
<b>6H</b> Lower Side Windows:	
Clear Laminated .....	601B
Tinted Laminated .....	601-BT
Standard Clear Lexan .....	601B-01
<b>6J</b> Door Window Mounting:	
Mounting Kit-Complete .....	602
<b>6K</b> Lower Side Windows Mounting:	
Mounting Kit-Complete .....	602-01
<b>6L</b> Center Post:	
Side Window Vertical Center Post .....	6001-0001
<b>5M</b> Window Latch:	
Locking w/Striker for Side Windows .....	6001-0001-A
<b>5N</b> Window Pulls:	
Mini-Pull for Side Window .....	6001-0002
Long Pull for Side Window .....	6001-0002-1
<b>6P</b> Door Seal:	
Trim & Seal Kit-Complete .....	604
<b>6Q</b> Threshold:	
Unit Kit-Complete .....	656/LH
<b>6R</b> Piano Style Hinge Kit:	
3/8" Dia Pin; 4" Open .....	6003-P
1/4" Dia Pin; 2-1/2" Open .....	6003-P-1
<b>6S</b> 2-Unit Male Hinge Kit:	
3/8" I.D. Barrel .....	6003-1
1/2" Pin for 9/16" I.D. Barrel .....	6003-2
9/16" C.R. Pin for 5/8" Barrel .....	6003-9-2
1/2" Pin for 9/16" I.D. Barrel (Spec Removeable) .....	6003-2-RF-1
<b>6T</b> 2-Unit Female Hinge Kit:	
3/8" I.D. Barrel .....	6003-1-F
9/16" I.D. Barrel for 1/2" Pin .....	6003-2-F
5/8" I.D. Barrel for 1/2" C.R. Pin .....	6003-9-F
9/16" I.D. Barrel for 1/2" Pin (Spec Removeable) .....	6003-2-RF

"Martin Cab", "Innovators", are registered Trademarks of Martin Sheet Metal Inc.  
 HV, Hi-Visibility, System 1-4 are all Trademarks of Martin Sheet Metal Inc.

**SECTION 6 (CONTINUED)**

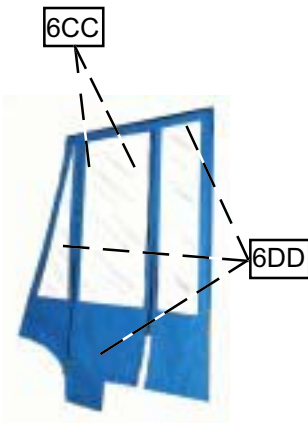
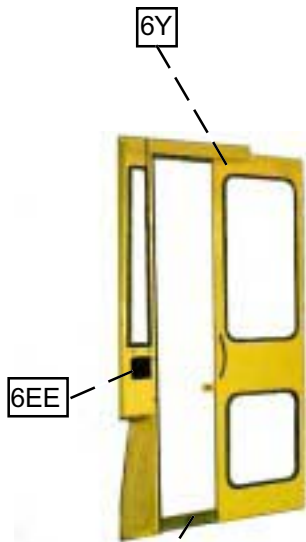
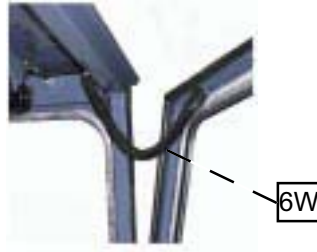

**Note:**

*Figure is for illustration purposes only; various cabs may differ.*

**LEFT SIDE DOOR PARTS**  
***Continued***

<u>Description</u>	<u>P/N</u>
<b>6U</b> 3-Unit Male Hinge Kit::	
3/8" I.B. Barrel .....	6003-1-3
1/2" Pin for 9/16" I.D. Barrel .....	6003-2-3
9/16: C.R. Pin for 5/8" Barrel .....	6003-9-3
<b>6V</b> 3-Unit Female Hinge Kit:	
9/16" I.D. Barrel for 1/2" Pin .....	6003-2-3-F
5/8" I.D. Barrel for 1/2" C.R. Pin .....	6003-9-3-F
<b>6W</b> Door Hold Back:	
Door Hold Back-Right (Rubber Plunger) .....	DHB-R
Door Hold Back Base-Complete (Female) .....	DHB/F
Door Hold Back Base-Complete (Male) .....	DHB/M
Door Hold Back Chain (Sleeved) .....	DHB/C
Door Hold Back Chain (2) (Sleeved) .....	DHB/C-2
<b>6X</b> Gas Cylinder:	
Cylinder Including Mounting Hardware .....	6001-1
<b>6Y</b> Sliding Track:	
Pair- 22" Long .....	60003/ST-01
Pair- 30" Long .....	60003/ST-02
Pair- 36" Long .....	60003/ST-03
<b>6Z</b> Fin Seal:	
Fin Trim & Seal Kit-Complete (Not Shown) .....	674/RH
<b>6AA</b> Side Fin Cover:	
Cover-Complete (Not Shown) .....	675/RH
<b>6BB</b> Fuel Fill:	
Cover Kit (Not Shown) .....	699/RH
<b>6CC</b> Fabric:	
Door Only .....	Fabric-5-01
<b>6DD</b> Fabric:	
Complete Panel .....	Fabric-5-04
<b>6EE</b> Latches <i>See Subsequent Listings</i>	

**SECTION 6 (CONTINUED)**

**LEFT SIDE DOOR PARTS**

*Continued*

**6EE LATCHES**

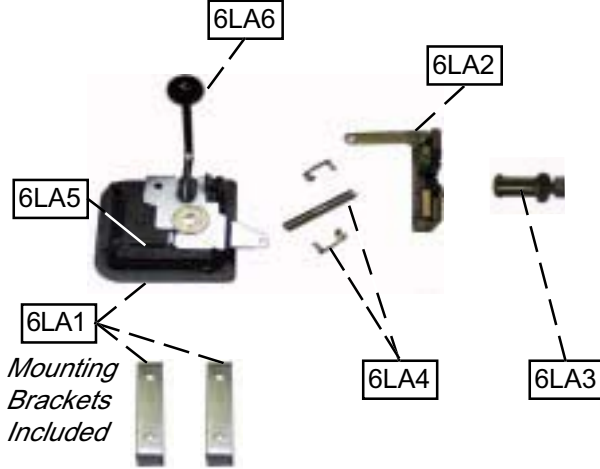

**6LA COMPLETE ASSEMBLY**

**BALL HANDLE STYLE**

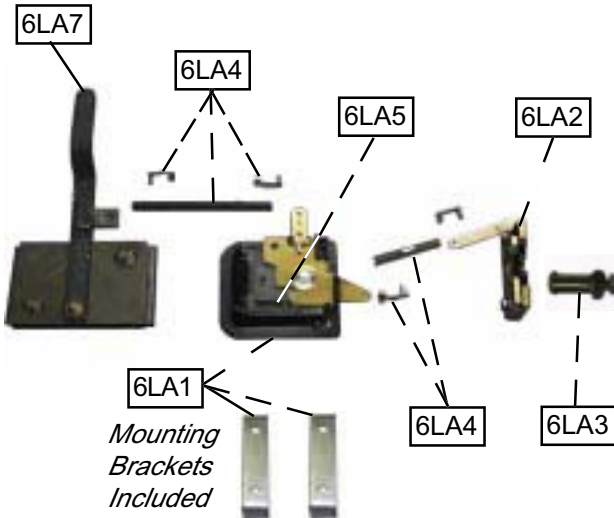

**6LA COMPLETE ASSEMBLY**

**LEVER HANDLE STYLE**

Note:

*Figure is for illustration purposes only; various cabs may differ.*

Description

P/N

<b>6LA</b>	Left Rotary Latch-Complete (Unkeyed)..... <i>Includes Pertinent Mounting Hardware</i>	6002-3
	Left Rotary Latch-Complete (Keyed)..... <i>Includes Pertinent Mounting Hardware</i>	6002-3-1
<b>6LA1</b>	Left Flush Paddle Latch - Outside ..... (Unkeyed Paddle Only) <i>Includes Pertinent Mounting Hardware</i>	6002-3-
	Left Flush Paddle Latch - Outside ..... (Keyed Paddle Only) <i>Includes Pertinent Mounting Hardware</i>	6002-3-1-
<b>6LA2</b>	Left Rotor Assembly Only ..... (For Rotary Latch Assembly)	6002-3-02
<b>6LA3</b>	Left Stricker Bolt ..... (w/Shoulder Washer and Hex Nut When Required)	6002-3-03
<b>6LA4</b>	Left Rotary Link with Clips.....	6002-3-04
<b>6LA5</b>	Left Return Spring .....	6002-3-9
<b>6LA6</b>	Left Plastic Ball.....	6002-3-91
<b>6LA7</b>	Inside Handle (w/Link If Required) ..... <i>Includes Pertinent Mounting Hardware</i>	6002-3-01

*Cab Model, Serial Number and Location  
**Extremely Important For The Latches  
 On This Page***

"Martin Cab", "Innovators", are registered Trademarks of Martin Sheet Metal Inc.  
 HV, Hi-Visibility, System 1-4 are all Trademarks of Martin Sheet Metal Inc.

**SECTION 6 (CONTINUED)**

**RIGHT SIDE DOOR PARTS**  
*Continued*

**6EE LATCHES**



Description

P/N

<b>6LB</b>	T-Type Standard (55): Left - Inside ..... 6002-01 <i>Includes Pertinent Mounting Hardware</i>
------------	---

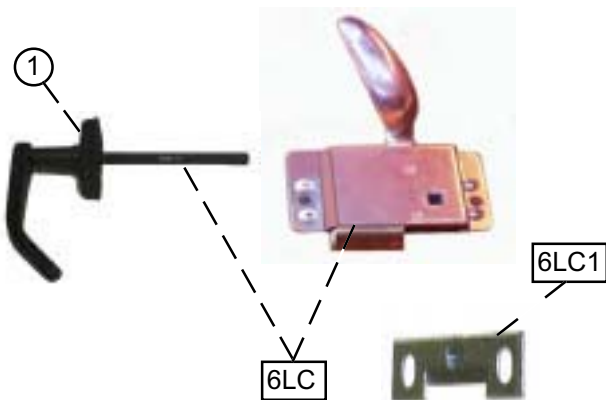

Description

P/N

<b>6LC</b>	T-Type Latch (55A) Inside - Complete ..... 6002-01 Outside (Unkeyed) - Complete ..... 6002-01-1 Outside (Keyed) - Complete ..... 6002-01-2
<b>6LC1</b>	Striker Only for T-Type Latch ..... 6002-01-3 (Right & Left Same)

① *Obsolete Part (Special Order)*

*Above Includes Pertinent Mounting Hardware where required*

Note:

*Figure is for illustration purposes only;  
 various cabs may differ.*

"Martin Cab", "Innovators", are registered Trademarks of Martin Sheet Metal Inc.  
 HV, Hi-Visibility, System 1-4 are all Trademarks of Martin Sheet Metal Inc.

# Generic Cab Program

## PARTS GUIDE

For assistance and for additional parts guides at no charge, please contact Martin Cab Service Parts toll free (888) 289-8900.

### SECTION 6 (CONTINUED)

#### RIGHT SIDE DOOR PARTS *Continued*

#### 6EE **LATCHES**

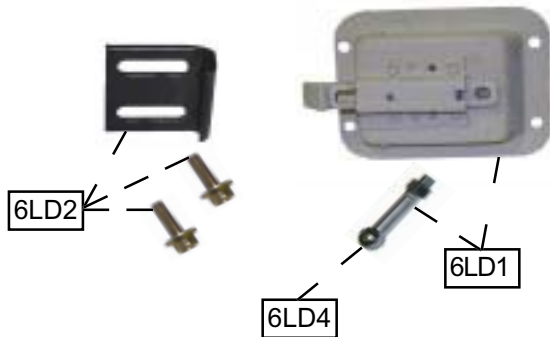

<u>Description</u>	<u>P/N</u>
<span style="border: 1px solid black; padding: 2px;">6LD1</span> Left Slam Latch Assembly: Unkeyed .....	6002-1
Keyed .....	6002-2
<span style="border: 1px solid black; padding: 2px;">6LD2</span> Standard Striker for Latch-Complete .....	6002-1-1
<span style="border: 1px solid black; padding: 2px;">6LD3</span> 90° Striker for Latch (Not Shown) .....	6002-1-2
<span style="border: 1px solid black; padding: 2px;">6LD4</span> Inside Extension Handle .....	6002-1-3

*Above Includes Pertinent Mounting Hardware where required*

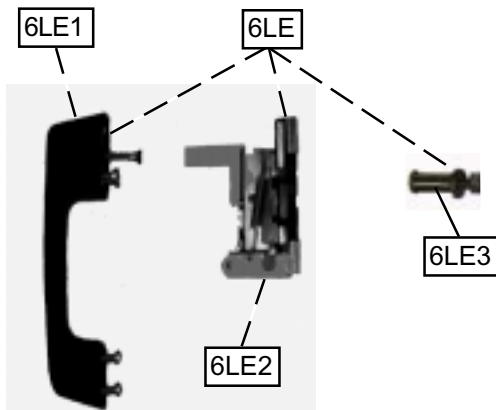

<u>Description</u>	<u>P/N</u>
<span style="border: 1px solid black; padding: 2px;">6LE</span> Grab Handle Latch Kit - Complete .....	6002-2-10
Locking Outside Handle Inside Latch Assembly Striker Bolt Mounting Hardware	
<span style="border: 1px solid black; padding: 2px;">6LE1</span> Grab Handle Latch - Outside .....	6002-2-11
Locking Outside Latch	
<span style="border: 1px solid black; padding: 2px;">6LE2</span> Grab Handle Latch .....	6002-2-12
Inside Latch Assembly	
<span style="border: 1px solid black; padding: 2px;">6LE3</span> Grab Handle Latch- Striker Bolt .....	6002-2-13
(w/Shoulder Washer and Hex Nut When Required)	

*Above Includes Pertinent Mounting Hardware where required*

**Note:**

*Figure is for illustration purposes only;  
various cabs may differ.*

"Martin Cab", "Innovators", are registered Trademarks of Martin Sheet Metal Inc.  
HV, Hi-Visibility, System 1-4 are all Trademarks of Martin Sheet Metal Inc.

**SECTION 7**

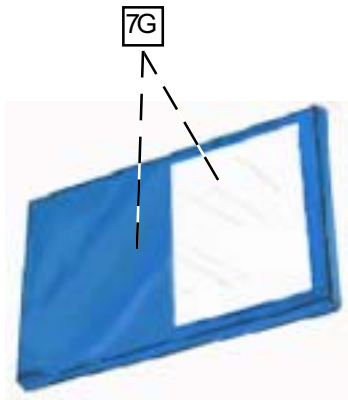
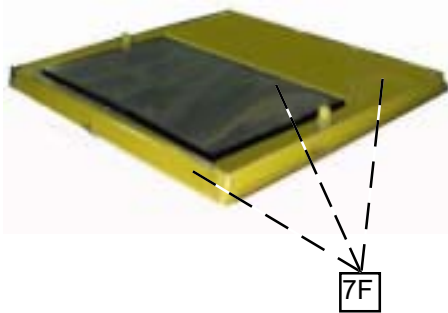
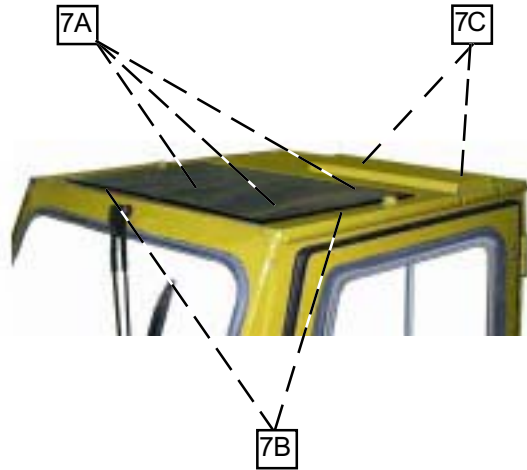

**ROOF TOP & SKYLIGHT**

<u>Description</u>	<u>P/N</u>
<b>7A</b> Skylight Window: Clear Laminated Glass .....	7001 LAM
Tinted Laminated Glass .....	7001 LAMT
Clear Lexan .....	7001 L
<b>7B</b> Skylight Window Mounting: Complete Skylight Window Mounting Kit .....	702
<b>7C</b> Battery Slot Cover: Battery Slot Cover w/Hinge and Latch .....	7001-03
<b>7D</b> Skylight Window Frame (Not Shown): Frame for Removeable Skylight .....	7001 F
<b>7E</b> Skylight Window Guard (Not Shown): Hinged, .312" Wire Mesh, 2" $\varnothing$ Guard Over Skylight Area .....	7001 G-01
<b>7F</b> Replacement Roof Top Roof Top Complete .....	7000-1
<b>7G</b> Fabric: Roof Top .....	Fabric-9
<b>7H</b> Wiper (Not Shown): <i>Optional Accessory for Roof Top</i> <i>See Volume 3 for Available Parts</i>	

Note:

*Figure is for illustration purposes only;  
 various cabs may differ.*

"Martin Cab", "Innovators", are registered Trademarks of Martin Sheet Metal Inc.  
 HV, Hi-Visibility, System 1-4 are all Trademarks of Martin Sheet Metal Inc.

**SECTION 8**

**SIDE PORTS**

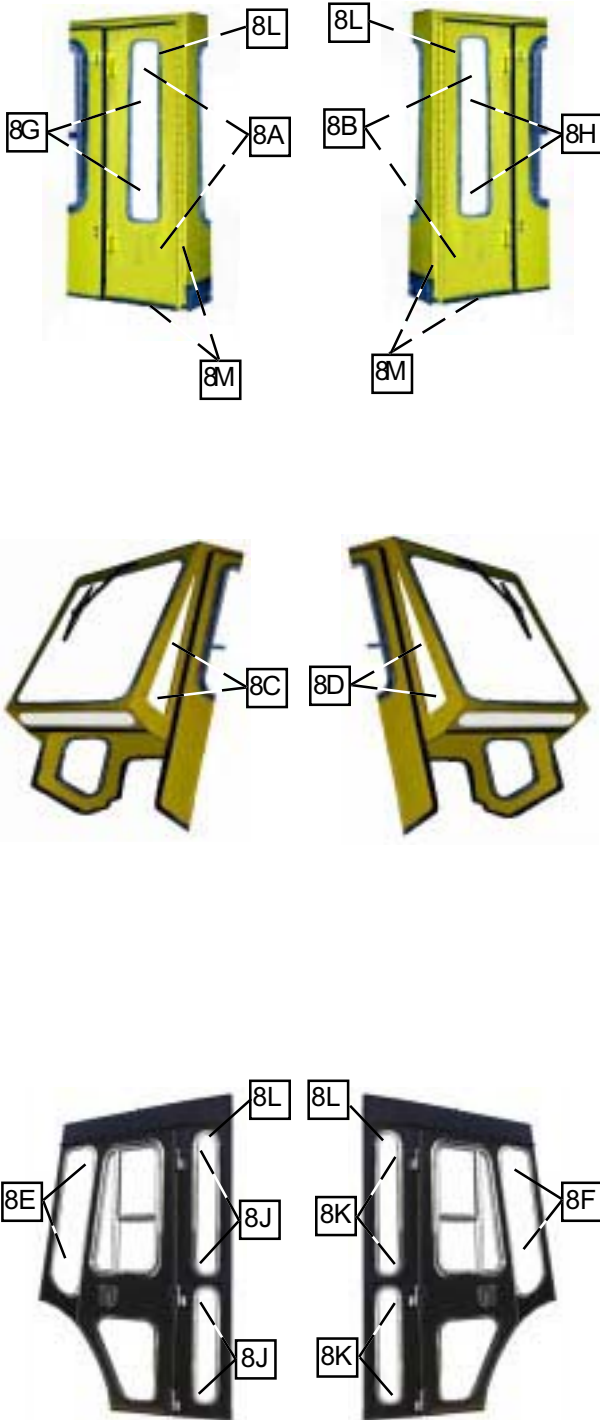

	<u>Description</u>	<u>P/N</u>
<b>8A</b>	Left Rear Steel Port Panels: Continuous Hinge - Clear Laminated .....	8000-L
	Continuous Hinge - Clear Lexan .....	8000-L-LEX
<b>8B</b>	Right Rear Steel Port Panels: Continuous Hinge - Clear Laminated .....	8000-R
	Continuous Hinge - Clear Lexan .....	8000-R-LEX
<b>8C</b>	Left Front Port Windows: Clear Lexan .....	8001-L
<b>8D</b>	Right Front Port Windows: Clear Lexan .....	8001-R
<b>8E</b>	Left Front Port Windows: Clear Lexan .....	801/L-LF
<b>8F</b>	Right Front Port Windows: Clear Lexan .....	801/L-RF
<b>8G</b>	Left Port Windows: Clear Laminated .....	801-LH
	Tinted Laminated-Complete .....	801/T
<b>8H</b>	Right Port Windows: Clear Laminated .....	801-RH
	Tinted Laminated-Complete .....	801/T
<b>8J</b>	Left Port Windows (Partial Height): Upper-Clear Laminated .....	801-LHU
	Lower-Clear Laminated .....	801-LHL
<b>8K</b>	Right Port Windows (Partial Height): Upper-Clear Laminated .....	801-RHU
	Lower-Clear Laminated .....	801-RHL
<b>8L</b>	Port Window Mounting: Rubber Kit-Complete .....	802
<b>8M</b>	Port Panel Seals: Trim & Seal Kit-Complete .....	804
	Body Gasket Seal Kit .....	804-B
<b>8N</b>	Front Port Panels (Not Shown): Left-Cont. Hinge w/5/16" Self Tapping Screws ...	8003-L-9
	Right-Cont. Hinge w/5/16" Self Tapping Screws .	8003-R-9

Note:

*Figure is for illustration purposes only;  
 various cabs may differ.*

"Martin Cab", "Innovators", are registered Trademarks of Martin Sheet Metal Inc.  
 HV, Hi-Visibility, System 1-4 are all Trademarks of Martin Sheet Metal Inc.

**Generic Cab Program**  
**PARTS GUIDE**

For assistance and for additional parts guides at no charge, please contact Martin Cab Service Parts toll free (888) 289-8900.

**SECTION 8 (CONTINUED)**

**SIDE PORTS**  
**Continued**

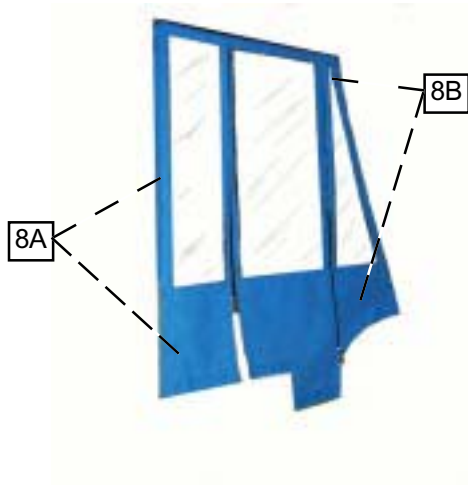

	<u>Description</u>	<u>P/N</u>
8A	Fabric Port Panel: Right Rear .....	Fabric-8-01
8B	Fabric Port Panel: Right Front .....	Fabric-3-05
8C	Fabric Port Panel: Left Rear .....	Fabric-8-02
8D	Fabric Port Panel: Left Front .....	Fabric-8-06

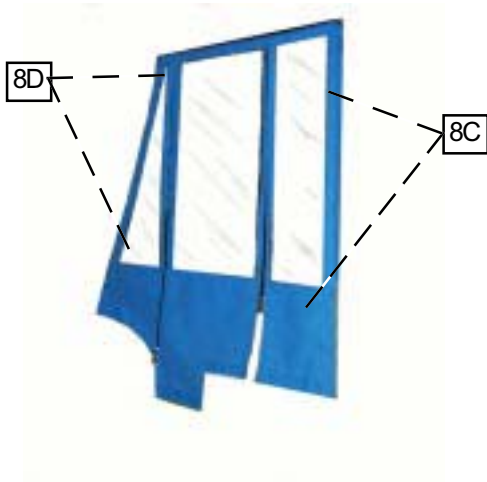

**Note:**

*Figure is for illustration purposes only;  
 various cabs may differ.*

"Martin Cab", "Innovators", are registered Trademarks of Martin Sheet Metal Inc.  
 HV, Hi-Visibility, System 1-4 are all Trademarks of Martin Sheet Metal Inc.

**SECTION 9**

**REAR HATCH & DOOR**

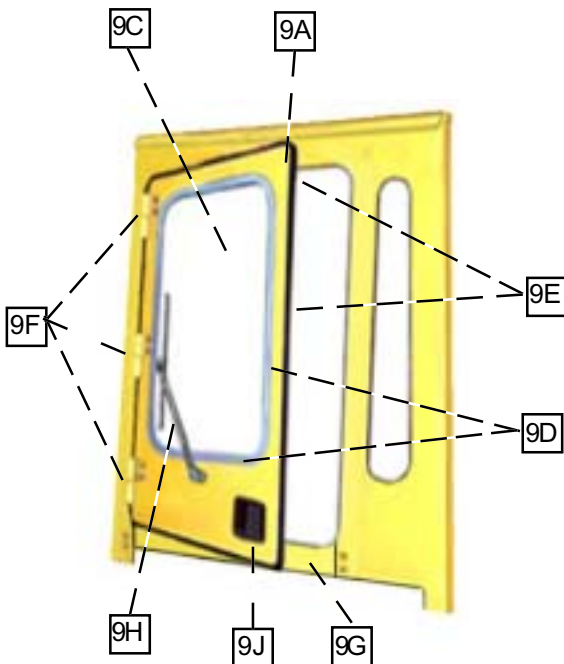

	<u>Description</u>	<u>P/N</u>
9A	Rear Hatch or Door: Clear Laminated .....	9000
9B	Hatch Support: GasSpring #SPD-GS-2250-120 .....	9001-1
9C	Rear Hatch/Door Window: Clear Laminated .....	901
	Clear Lexan .....	901/L
9D	Rear Hatch/Door Window Rubber Kit: Complete .....	902
9E	Rear Hatch/Door Seal: Tim & Seal Kit-Complete .....	904
9F	Rear Hinges: 2-Unit Male Hinge Kit - 9/16" ID Barrel .....	9003
	2-Unit Male Hinge Kit - 3/8" ID Barrel .....	9003-1
	3-Unit Male Hinge Kit - 3/8" ID Barrel .....	9003-1-3
	2-Unit Female Hinge Kit - 9/16" ID Barrel .....	9003-2-F
	3-Unit Male Hinge Kit - 9/16" ID Barrel .....	9003-3
9G	Rear Hatch/Door Filler: Lower Door - Complete .....	9056
9H	Wiper <i>Optional Accessory for Rear Hatch/Door</i> <i>See Volume 3 for Available Parts</i>	
9J	Rear Door/ Hatch Latches <i>See Subsequent Listings</i>	

Latches *See Subsequent Listings*

**Note:**

*Figure is for illustration purposes only;  
 various cabs may differ.*

"Martin Cab", "Innovators", are registered Trademarks of Martin Sheet Metal Inc.  
 HV, Hi-Visibility, System 1-4 are all Trademarks of Martin Sheet Metal Inc.

**Generic Cab Program**  
**PARTS GUIDE**

For assistance and for additional parts guides at no charge, please contact Martin Cab Service Parts toll free (888) 289-8900.

**SECTION 9 (CONTINUED)**

**REAR HATCH & DOOR**

**Continued**

**9J LATCHES**

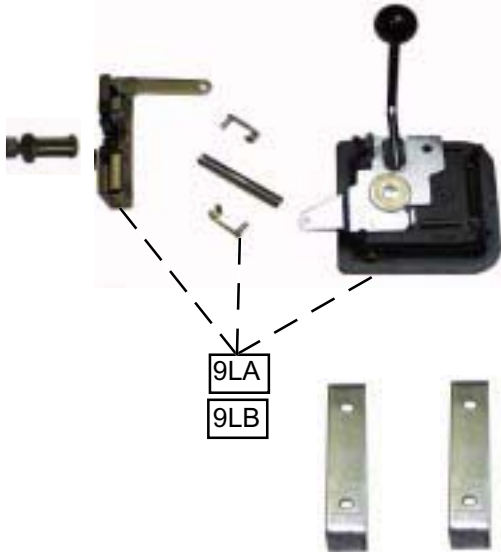

*Mounting Brackets Included*

Description

P/N

**9LA** Flush Rotary Latch Ass'y Complete ..... 9002-3  
 w/Unkeyed Paddle  
 Links if Required  
 Inside Handle if Required  
 Rotary Jaw Unit  
 Striker Bolt

*Includes Pertinent Mounting Hardware*

**9LB** Flush Rotary Latch Ass'y Complete ..... 9002/KL  
 w/Unkeyed Paddle  
 Links if Required  
 Inside Handle if Required  
 Rotary Jaw Unit  
 Striker Bolt

*Includes Pertinent Mounting Hardware*

Description

P/N



**9LC**

**9LC** Rear Door Flush Latch:  
 Complete ..... 9002

*Includes Pertinent Mounting Hardware*

Description

P/N

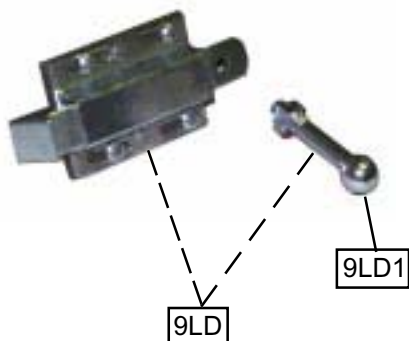

**9LD** End Bolt Assy:  
 Kit Complete ..... 9001  
*Includes Pertinent Mounting Hardware*

**9LD1** Inside Extension Handle ..... 6002-1-3

Note:

*Figure is for illustration purposes only;  
 various cabs may differ.*

"Martin Cab", "Innovators", are registered Trademarks of Martin Sheet Metal Inc.  
 HV, Hi-Visibility, System 1-4 are all Trademarks of Martin Sheet Metal Inc.

**SECTION 9 (CONTINUED)**

**REAR HATCH & DOOR**

**Continued**

**9J LATCHES**



Description P/N

**9LE1** T-Type Standard (55):  
 Left - Inside .....  
*Includes Pertinent Mounting Hardware*

**9LE2** T-Type Standard (55):  
 Right - Inside .....  
*Includes Pertinent Mounting Hardware*

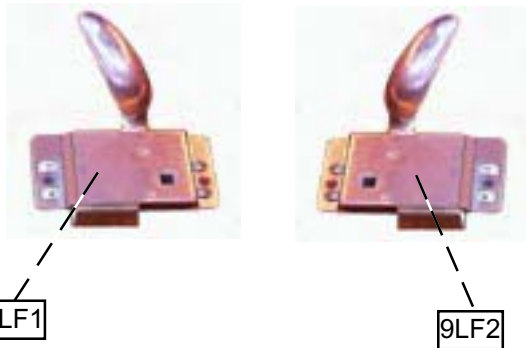

Description P/N

**9LF1** T-Type Heavy Duty (55A):  
 Left - Inside Heavy Duty ..... 9002-01-1  
*Includes Pertinent Mounting Hardware*

**9LF2** T-Type Heavy Duty (55A):  
 Right - Inside ..... 9002-01  
*Includes Pertinent Mounting Hardware*

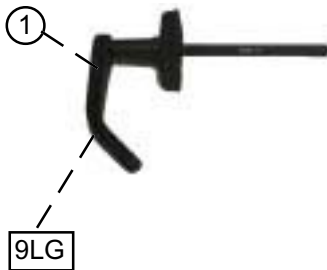

Description P/N

**9LG** T-Type :  
 Right - Outside ..... 9002-01-2  
*Includes Pertinent Mounting Hardware*

① *Obsolete Part (Special Order)*



Description P/N

**9LH** Strikers:  
 Striker for Latch - Complete ..... 9002-1  
*Includes Pertinent Mounting Hardware*

Note:

*Figure is for illustration purposes only;  
 various cabs may differ.*

"Martin Cab", "Innovators", are registered Trademarks of Martin Sheet Metal Inc.  
 HV, Hi-Visibility, System 1-4 are all Trademarks of Martin Sheet Metal Inc.



# Reference Manual

## WINDOW MATERIAL

Various transparent materials are available for the windows in a Martin Cab.

For cabs and replacement parts produced subsequent to February 1, 2001, the preferred material for all clear windows, except the front windshield, will be 3/16" thick "Modified Acrylic". Implementation will affect **clear laminated glass** product only. Other windows may include Modified Acrylic, Lexan or laminated glass materials.

Specific cab model update effectivity will be at the discretion of Martin Cab.

For parts ordering purposes, the suffix "MA" will be appended to the clear laminated glass number to indicate "Modified Acrylic". An example of the modified numbers is shown below:

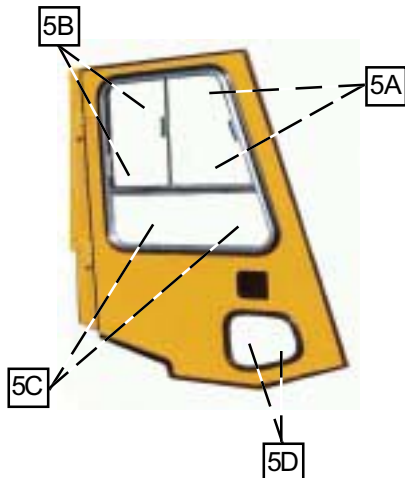

<b>5A</b>	Side Window-3 Piece, Front:	
	* Clear Laminated .....	501F-1
	* Clear Modified Acrylic .....	501F-1-MA
	Tinted Laminated .....	501F-1T
<b>5B</b>	Side Window-3 Piece, Rear:	
	* Clear Laminated .....	501R-1
	* Clear Modified Acrylic .....	501R-1-MA
	Tinted Laminated .....	501R-1T
<b>5C</b>	Side Window-3 Piece, Stationary:	
	* Clear Laminated .....	501S-1
	* Clear Modified Acrylic .....	501S-1-MA
	Tinted Laminated .....	501S-1T
<b>5D</b>	Lower Side Windows:	
	* Clear Laminated .....	501B
	* Clear Modified Acrylic .....	501B-MA
	Tinted Laminated .....	501B-T
	Standard Clear Lexan .....	501B-01

\* Clear Laminated Glass Number  
\*\* Modified Acrylic Number